



Catalogue
LAUNDRY
Chapter
DRYERS

Model
SR-35 TP2 S 230V 1N 50/60Hz

18003127

14/02/2020

ADVANCE DRYER, SR-35 TP2 S

KEY FEATURES:

01. TOUCH PLUS CONTROL "TP2"

Fully programmable Touch plus control that offers the possibility to create, export and import new programmes (USB). It includes a touchscreen that is very intuitive and easy to use, 37 available languages and a USB port for software updates.

02. iDry

Moisture sensor, together with the temperature sensor at drum entry, offers precise control over the moisture levels of clothing. The system automatically stops the drying cycle as soon as the established residual moisture level has been reached. This avoids unnecessary prolongation of the drying cycle and the wear of clothing, while significantly reducing energy consumption.

03. FIRE CARE SYSTEM

As an option. It is instantly activated in case of fire within the dryer basket, providing users with maximum safety.

OPL <-> SELF-SERVICE

The machines can be converted from OPL to Selfservice and vice versa from the TP2 control.

- Fully programmable Touch Plus Control Processor (TP2) with 4.3" touchscreen.
- External steel casing with grey coating (skinplate), stainless steel, easy to clean finish.
- Stainless steel drum.
- Axial-radial airflow, resulting in greater drying efficiency.
- Drum with stamped perforations for the gentle treatment of fabrics.
- Lint filter at the bottom, more ergonomic, larger and improved airflow.
- Automatic reverse rotation of the drum.
- Frequency inverter for smoother operation.
- Ergonomic door with a large opening and the option of double glazing.
- Anti-wrinkle system.
- End of cycle tone.
- Emergency stop button and security micro magnet to stop operation
- Pulley and Poly-V belt transmission system with the drum supported on wheels.

OPTIONS:

- Reverse opening door.
- Stainless steel casing.
- Stainless steel front.
- Wooden packaging.
- Air intake filter.
- Fluff filter.
- Tropicalised electronics.
- WI-FI
- Printer.
- Dosing.
- Double glazed door.
- 7" Screen.
- iDry System (Intelligent moisture sensor + temperature control at the drum entrance).
- Double skin that provides thermal insulation for the best possible

DIMENSIONS

X Width	985 mm	X Gross width	1065 mm
Y Depth	1210 mm	Y Gross depth	1310 mm
Z Height	1946 mm	Z Gross height	2080 mm
Net Weight	260,0 kg	Gross Weight	285,0 kg
Net volume	2,320 m3	Gross volume	2,902 m3

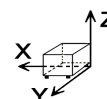

ELECTRICITY TECHNICAL SPECIFICATIONS

Engine power	0,55 kW
Fan Motor Power	0,55 kW
Electric power	1,150 kW
Amperage (A)	5,0
Voltage	230V - 1N
Electric frequency	50/60Hz

STEAM TECHNICAL SPECIFICATIONS

Steam consumption	89,00 kg/h
Steam power	50,10 kW
Steam pressure	6,00 - 9,00 bar

AIR TECHNICAL SPECIFICATIONS

Maximum airflow	1200 m3/h
-----------------	-----------

CONNECTIONS TECHNICAL SPECIFICATIONS

230 V three-phase wiring	3 X 1,5 / 20A
Single-phase 230V wiring	3 X 1,5 / 20A
Three-phase +N 400V wiring	3 X 1,5 / 20A
Steam entrance diameter	1"
Steam exit diameter	1"
Extraction 1 diameter	200,00 mm

OTHERS

Load capacity 1/18	36,70 kg
Load capacity 1/20	33,00 kg
Drum volume	660 L
Drum diameter	947 mm
Drum depth	936 mm
Hourly Output **	60,0 kg/h
Evaporation capacity *	31,1 L/h
Noise level	65,00 dB





Catalogue
LAUNDRY

Chapter
DRYERS

Model
SR-35 TP2 S 230V 1N 50/60Hz

18003127

14/02/2020

energy efficiency.
- FK System (Integrated fire prevention system).

Placement of the door:
Door center height: 1040 mm
Door base height: 577 mm
Door opening diameter: 802 mm

* Drying conditions: complete loading (1/20) of towels, drying temperature 90°C.

*** kg dry clothes per hour. Drying conditions: complete loading (1/20) of towels, drying temperature 90°C.

"



Catalogue
LAUNDRY

Chapter
DRYERS

Model
SR-35 TP2 S 230V 1N 50/60Hz

18003127

14/02/2020

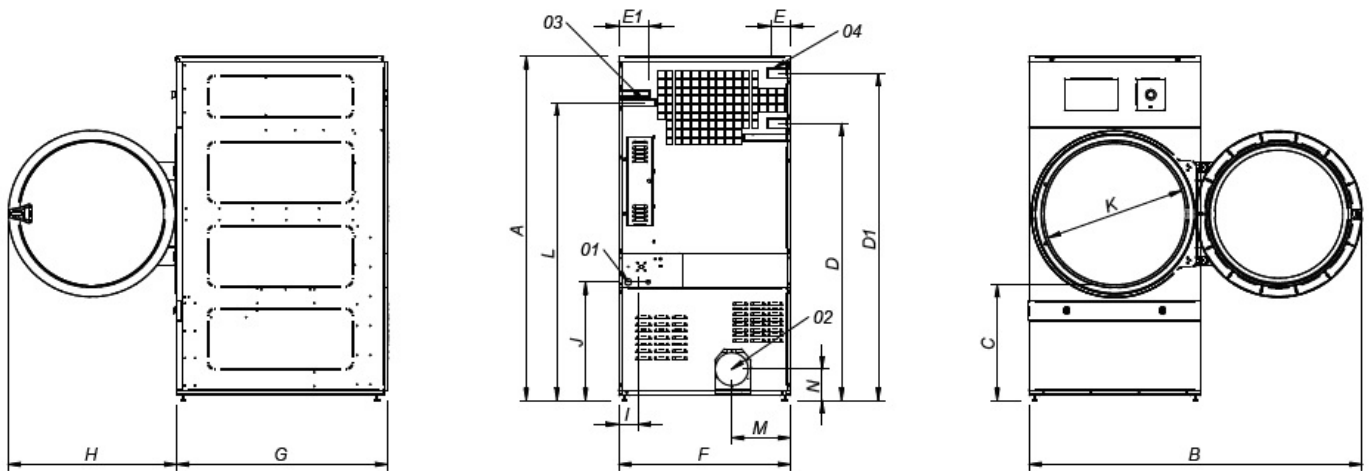

01 ACOMETIDA ELÉCTRICA
02 S ALIDA VAHOS Ø20 0
03 ENTRAD A GAS 1/2"
04 ENTRAD A VAPOR 1"

01 ELECTRIC CONNECTION
02 FUMES OUTLET Ø200
03 GAS CONNECTION 1/2"
04 STEAM CONNECTION 3/4"

	A	B	C	D	D1	E	E1	F	G	H	I	J	K	L	M	N
SR-28	1946	1910	640	1590	1875	113	174	985	1054	957	110	680	802	1707	337	178
SR-35	1946	1910	640	1590	1875	113	174	985	1210	957	110	680	802	1707	337	178