



Catalogue
LAUNDRY
Chapter
WASHING

Model
LA-35 TP2 E 400V 3N 50/60Hz

18001868

12/05/2020

HIGH SPIN WASHER EXTRACTOR, LA-35 TP2 E

- Unit exterior manufactured in skin plate, colour grey, stainless steel appearance. Easy to clean and anti fingerprint.
- Drum and jacket in AISI-304 stainless steel.
- 8 automatic liquid dosing signals, with programmable time and delay. 6 extra signals available optionally.
- 3 standard water inlets.
- Variable-frequency drive (standard 50-60 Hz). Balancing system controlled by the same drive.
- New second-generation TOUCH PLUS programmer with 7" touch screen, 37 available languages and which lets you create an indefinite number of programs (29 pre-set), even play videos.
- Traceability as standard: the whole wash process (temperatures, water levels) is stored on the washer and is extractable to a PC by USB memory.
- Allows programming, importing and exporting of programs and software updates via USB.
- WET CLEANING characteristics included in the scheduler (modifiable water levels and washing speed).
- EFFICIENT MIX. These machines are equipped with an automatic water mixer (mixing different water temperatures) which provides energy savings and reduces washing times.
- BALANCE CONTROL. The washers detect the imbalance at an early stage. This way the operation is much smoother, elongating components lifetime and reducing washing times, thus saving energy as well.
- MULTICHOICE INLET. All washers are equipped with a third water inlet as standard, which allows you to save filling time, or which can be used for decalcified water, ozone or recycled water.
- MAINTENANCE KARE. A simple and reliable design with easy-to-access mechanical parts.
- OPTIMIZED DRUM. The effective design of the drum and tank allows the energy consumption necessary to heat the water, as well as the superfluous use of chemical products, to be reduced.
- OPTIMAL CONSUMPTION: Efficient system by means of which you can indicate the load which is introduced in the machine. The washer automatically adapts the quantity of water and chemicals to be used for that load.
- LOADING AID system. Water inlet and spin control for loading the linen.
- CE, WRAS and EAC product certifications.
- Optional ETL-certified version of the machine.
- Tank with 4 detergent compartments.
- The standard model can be converted to self-service by installing a pay station kit, coin mechanism kit or other payment system. RS-485 communication.
- Washers compatible with water recovery tanks.
- Maximum water consumption calculated in Programme nr. 20, 75% of loading.

OPTIONS:

- Reversible door.
- Automatic unblockage of the door.
- Tropicalised programmer.
- Levelling feet.
- Printer.
- Recirculation.
- Extra dosage.
- Automatic weighing.
- Stainless steel unit

DIMENSIONS

X Width	1095 mm	X Gross width	1165 mm
Y Depth	1184 mm	Y Gross depth	1230 mm
Z Height	1598 mm	Z Gross height	1920 mm
Net Weight	750,0 kg	Gross Weight	820,0 kg
Net volume	2,070 m3	Gross volume	2,751 m3



ELECTRICITY TECHNICAL SPECIFICATIONS

Engine power	4,00 kW
Electric power	22,000 kW
Amperage (A)	35,5
Heating power	21,00 kW
Voltage	400V - 3N
Electric frequency	50/60Hz

WATER TECHNICAL SPECIFICATIONS

Pressure	H2O: 200-400kPa(2-4bar)
Water max consumption	261,30 L/h

CONNECTIONS TECHNICAL SPECIFICATIONS

Single-phase 230V wiring	0
Three-phase +N 400V wiring	4X6+T 40A
Water inlet diameter	3/4"
Drain 1 diameter	3"
Drainage capacity	200 l/min

OTHERS

Load capacity 1/9	39,00 kg
Load capacity 1/10	35,00 kg
Drum volume	350 L
Drum diameter	860 mm
Drum depth	602 mm
Wash speed	42,5 r.p.m.
Max revolutions	966 r.p.m.
G Factor	450
Fuerza máxima transmitida (kN)	7,36 ±2,45
Frequency of dynamic load (Hz)	14,30
Self-service	No
Noise level	< 70,00 dB





Catalogue
LAUNDRY

Chapter
WASHING

Model
LA-35 TP2 E 400V 3N 50/60Hz

18001868

12/05/2020

- Stainless steel front.
- Drain normally closed.
- Double drain.

Door position:

Height door centre: 885 mm

Height door base: 540 mm

"Working diameter of the door: 560 mm

"





Catalogue
LAUNDRY

Chapter
WASHING

Model
LA-35 TP2 E 400V 3N 50/60Hz

18001868

12/05/2020

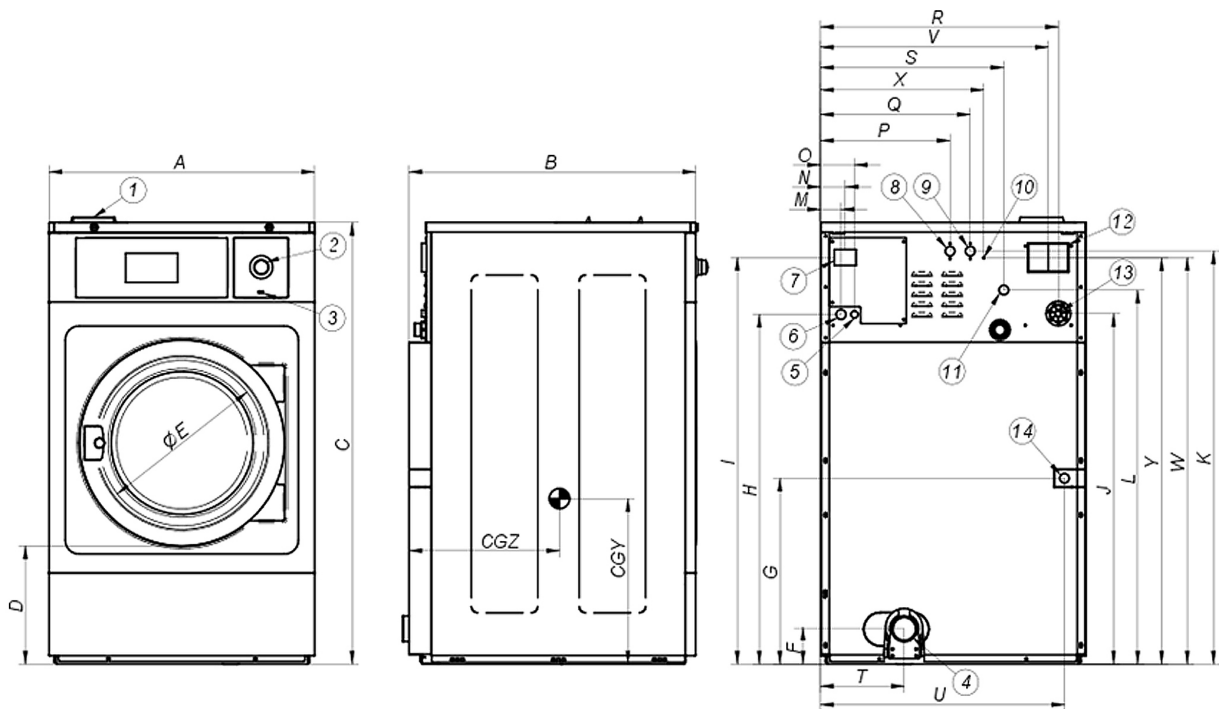

	A	B	C	D	E	F	G	H	I	J	K	L	M	N	O	P	Q	R	S	T	U	V	W	X	Y	CGY	CGZ
LA-25 TP2	979	1.041	1.553	560	460	133	490	1.282	1.450	1.259	1.465	1.354	61	74	101	481	561	861	673	367	909	831	1.424	624	1.510	773	710
LA-35 TP2	1.095	1.184	1.598	540	525	158	576	1.330	1.498	1.297	1.513	1.383	61	74	101	596	676	976	808	384	1.028	946	1.462	861	1.558	795	732

- | | |
|--|--|
| 01. Jabonera | 01. Detergent box |
| 02. STOP paro de emergencia | 02. STOP Emergency button |
| 03. Puerto USB | 03. USB port |
| 04. desagüe | 04. Drain |
| 05. Conexión eléctrica a bombas de jabón líquido | 05. Electrical connection for soap dispenser |
| 06. Conexión eléctrica | 06. Electrical inlet |
| 07. Interruptor general | 07. Main switch |
| 08. Entrada de agua auxiliar | 08. Auxiliary water inlet |
| 09. Entrada de agua caliente | 09. Hot water inlet |
| 10. Toma de tierra | 10. Ground connection |
| 11. Entrada de agua fría | 11. Cold water inlet |
| 12. Rebosadero de agua | 12. Overflow |
| 13. Conexión para jabón líquido | 13. Connection for liquid soap |
| 14. Conexión de vapor | 14. Steam inlet |