



Catalogue
LAUNDRY
Chapter
DRYERS

Model
SR-60 TP2 E 400V 3N 50Hz

18003143

14/02/2020

ADVANCE DRYER, SR-60 TP2 E

KEY FEATURES:

01. TOUCH PLUS CONTROL "TP2"

Fully programmable Touch plus control that offers the possibility to create, export and import new programmes (USB). It includes a touchscreen that is very intuitive and easy to use, 37 available languages and a USB port for software updates.

02. iDry

Moisture sensor, together with the temperature sensor at drum entry, offers precise control over the moisture levels of clothing. The system automatically stops the drying cycle as soon as the established residual moisture level has been reached. This avoids unnecessary prolongation of the drying cycle and the wear of clothing, while significantly reducing energy consumption.

03. FIRE CARE SYSTEM

As an option. It is instantly activated in case of fire within the dryer basket, providing users with maximum safety.

OPL <-> SELF-SERVICE

The machines can be converted from OPL to Selfservice and vice versa from the TP2 control.

- Fully programmable Touch Plus Control Processor (TP2) with 7" touchscreen.
- External steel casing with grey coating (skinplate), stainless steel, easy to clean E9finish.
- Stainless steel drum.
- Axial-radial airflow, resulting in greater drying efficiency.
- Drum with stamped perforations for the gentle treatment of fabrics.
- Lint filter at the bottom, more ergonomic, larger and improved airflow.
- Automatic reverse rotation of the drum.
- Frequency inverter for smoother operation.
- Ergonomic door with a large opening and the option of double glazing.
- Anti-wrinkle system.
- End of cycle tone.
- Emergency stop button and security micro magnet to stop operation
- Pulley and Poly-V belt transmission system with the drum supported on wheels.

OPTIONS:

- Reverse opening door.
- Stainless steel casing.
- Stainless steel front.
- Wooden packaging.
- Air intake filter.
- Fluff filter.
- Tropicalised electronics.
- WI-FI
- Printer.
- Dosing.
- Double glazed door.
- 7" Screen.
- iDry System (Intelligent moisture sensor + temperature control at the drum entrance).
- FK System (Integrated fire prevention system)

DIMENSIONS

X Width	1270 mm	X Gross width	1330 mm
Y Depth	1366 mm	Y Gross depth	1455 mm
Z Height	2380 mm	Z Gross height	2150 mm
Net Weight	529,0 kg	Gross Weight	575,0 kg
Net volume	4,130 m3	Gross volume	4,161 m3

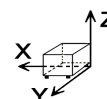

ELECTRICITY TECHNICAL SPECIFICATIONS

Engine power	1,10 kW
Fan Motor Power	1,10 kW
Electric power	74,250 kW
Amperage (A)	107,3
Heating power	72,00 kW
Voltage	400V - 3N
Electric frequency	50Hz

AIR TECHNICAL SPECIFICATIONS

Maximum airflow	3000 m3/h
-----------------	-----------

CONNECTIONS TECHNICAL SPECIFICATIONS

Three-phase +N 400V wiring	5 X 50 / 125A
Extraction 1 diameter	300,00 mm

OTHERS

Load capacity 1/18	66,80 kg
Load capacity 1/20	60,10 kg
Drum volume	1202 L
Drum diameter	1225 mm
Drum depth	1020 mm
Hourly Output **	120,0 kg/h
Evaporation capacity *	60,2 L/h
Noise level	67,00 dB



Catalogue
LAUNDRY

Chapter
DRYERS

Model
SR-60 TP2 E 400V 3N 50Hz

18003143

14/02/2020

Placement of the door:
Door center height: 1275 mm
Door base height: 812 mm
Door opening diameter: 802 mm

* Drying conditions: complete loading (1/20) of towels, drying temperature 90°C.

*** kg dry clothes per hour. Drying conditions: complete loading (1/20) of towels, drying temperature 90°C.

"



Catalogue
LAUNDRY

Chapter
DRYERS

Model
SR-60 TP2 E 400V 3N 50Hz

18003143

14/02/2020

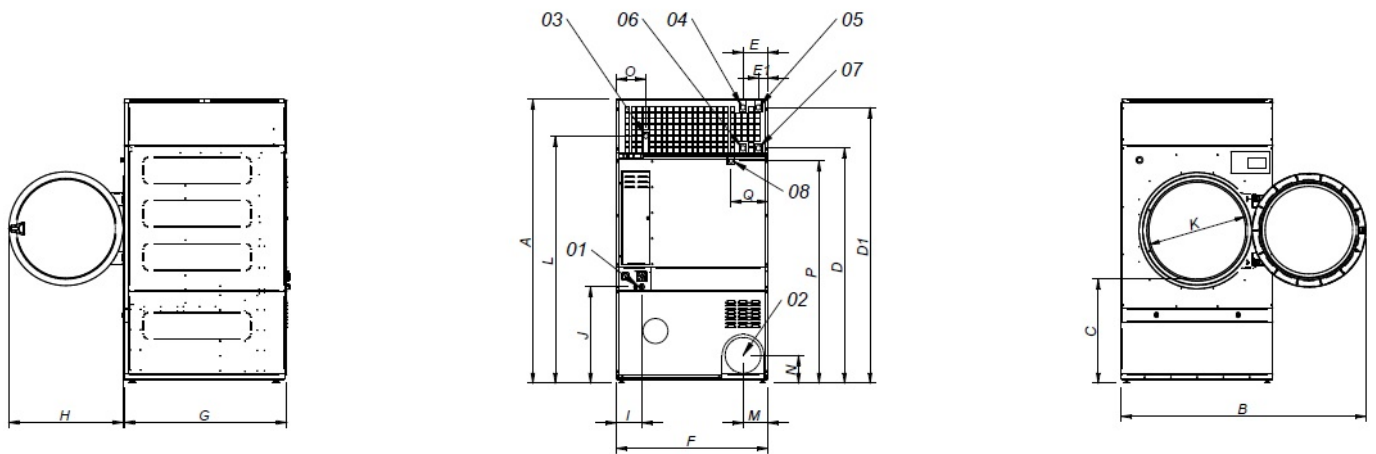

- 01 ACOMETIDA ELECTRICA
- 02 SALIDA VAHOS Ø300
- 03 ENTRADA GAS 3/4"
- 04 ENTRADA VAPOR (DTT-45) 1"
- 05 ENTRADA VAPOR (DTT-60/80) 1"
- 06 SALIDA CONDENSADOS (DTT-45) 1"
- 07 SALIDA CONDENSADOS (DTT-60/80) 1"
- 08 VALVULA ANTI INCENDIO 3/4"

- 01 ELECTRIC CONNECTION
- 02 FUMES OUTLET Ø300
- 03 GAS CONNECTION 3/4"
- 04 STEAM CONNECTION (DTT-45) 1"
- 05 STEAM CONNECTION (DTT-60/80) 1"
- 06 CONDENSATION OUTLET (DTT-45) 1"
- 07 CONDENSATION OUTLET (DTT-60/80) 1"
- 08 FIRE EXTINGUISHER WATER VALVE 3/4"

	A	B	C	D	E	E1	F	G	H	I	J	K	L	M	N	O	P	Q
SR-45	2380	2045	874	1981	211	80	1270	1106	957	138	813	802	2088	214	240	244	1865	195
SR-60	2380	2045	874	1981	211	80	1270	1366	957	138	813	802	2088	214	240	244	1865	195
SR-80	2380	2045	874	1981	211	80	1270	1598	957	138	813	802	2088	214	240	244	1865	195