



Catalogue
LAUNDRY
Chapter
DRYERS

Model
SR-11 TP2 S 230V 1N 50/60Hz

18003085

14/02/2020

ADVANCE DRYER, SR-11 TP2 S

KEY FEATURES:

01. TOUCH PLUS CONTROL "TP2"

Fully programmable Touch plus control that offers the possibility to create, export and import new programmes (USB). It includes a touchscreen that is very intuitive and easy to use, 37 available languages and a USB port for software updates.

02. iDry

Moisture sensor, together with the temperature sensor at drum entry, offers precise control over the moisture levels of clothing. The system automatically stops the drying cycle as soon as the established residual moisture level has been reached. This avoids unnecessary prolongation of the drying cycle and the wear of clothing, while significantly reducing energy consumption.

03. FIRE CARE SYSTEM

As an option. It is instantly activated in case of fire within the dryer basket, providing users with maximum safety.

OPL <-> SELF-SERVICE

The machines can be converted from OPL to Selfservice and vice versa from the TP2 control.

- Fully programmable Touch Plus Control Processor (TP2) with 4.3" touchscreen.
- External steel casing with grey coating (skinplate), stainless steel, easy to clean finish.
- Stainless steel drum.
- Axial-radial airflow, resulting in greater drying efficiency.
- Drum with stamped perforations for the gentle treatment of fabrics.
- Lint filter at the bottom, more ergonomic, larger and improved airflow.
- Automatic reverse rotation of the drum.
- Frequency inverter for smoother operation.
- Ergonomic door with a large opening and the option of double glazing.
- Anti-wrinkle system.
- End of cycle tone.
- Emergency stop button and security micro magnet to stop operation
- Motion transmission by geared motor

OPTIONS:

- Reverse opening door.
- Stainless steel casing.
- Stainless steel front.
- Wooden packaging.
- Air intake filter.
- Fluff filter.
- Tropicalised electronics.
- WI-FI
- Printer.
- Dosing.
- Double glazed door.
- 7" Screen.
- iDry System (Intelligent moisture sensor + temperature control at the drum entrance).
- Double skin that provides thermal insulation for the best possible energy efficiency

DIMENSIONS

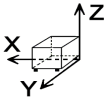

X Width	785 mm	X Gross width	865 mm
Y Depth	855 mm	Y Gross depth	940 mm
Z Height	1694 mm	Z Gross height	1840 mm
Net Weight	172,0 kg	Gross Weight	180,0 kg
Net volume	1,140 m3	Gross volume	1,496 m3

ELECTRICITY TECHNICAL SPECIFICATIONS

Engine power	0,37 kW
Fan Motor Power	0,25 kW
Electric power	0,670 kW
Amperage (A)	2,9
Voltage	230V - 1N
Electric frequency	50/60Hz

STEAM TECHNICAL SPECIFICATIONS

Steam consumption	53,00 kg/h
Steam power	30,00 kW
Steam pressure	6,00 - 9,00 bar

AIR TECHNICAL SPECIFICATIONS

Maximum airflow	850 m3/h
-----------------	----------

CONNECTIONS TECHNICAL SPECIFICATIONS

230 V three-phase wiring	3 X 1,5 / 20A
Single-phase 230V wiring	3 X 1,5 / 20A
Three-phase +N 400V wiring	3 X 1,5 / 20A
Steam entrance diameter	3/4"
Steam exit diameter	3/4"
Extraction 1 diameter	200,00 mm

OTHERS

Load capacity 1/18	11,70 kg
Load capacity 1/20	10,50 kg
Drum volume	210 L
Drum diameter	750 mm
Drum depth	475 mm
Hourly Output **	20,3 kg/h
Evaporation capacity *	9,3 L/h
Noise level	64,00 dB



Catalogue
LAUNDRY

Chapter
DRYERS

Model
SR-11 TP2 S 230V 1N 50/60Hz

18003085

14/02/2020

- FK System (Integrated fire prevention system).

Placement of the door:

Door center height: 976 mm

Door base height: 618 mm

Door opening diameter: 574 mm

* Drying conditions: complete loading (1/20) of towels, drying temperature 90°C.

*** kg dry clothes per hour. Drying conditions: complete loading (1/20) of towels, drying temperature 90°C.

"



Catalogue
LAUNDRY

Chapter
DRYERS

Model
SR-11 TP2 S 230V 1N 50/60Hz

18003085

14/02/2020

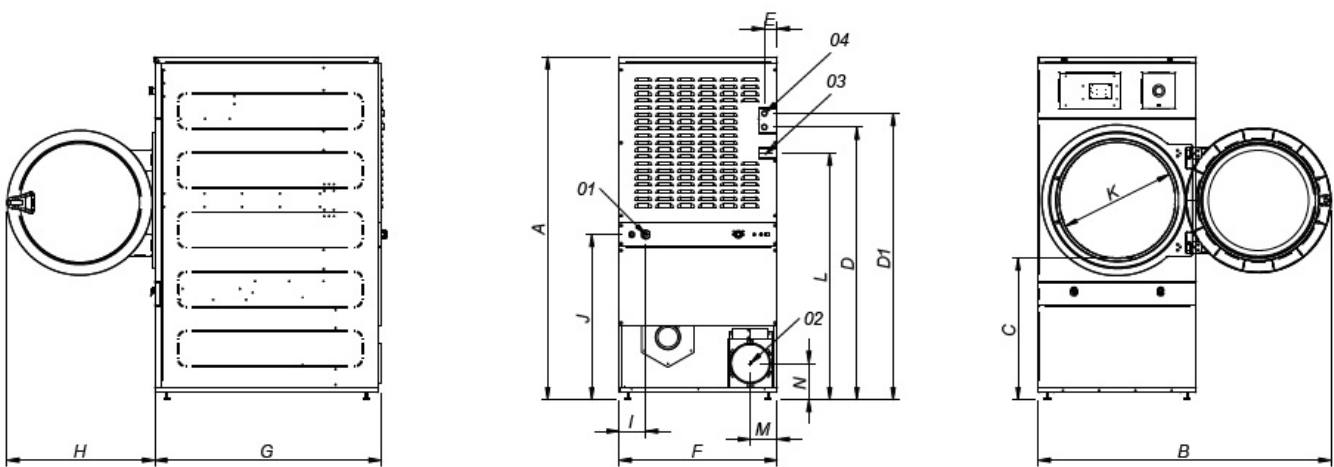

01 ACOMETIDA ELÉCTRICA
02 SALIDA VAHOS Ø200
03 ENTRADA GAS 1/2"
04 ENTRADA VAPOR 3/4"

01 ELECTRIC CONNECTION
02 FUMES OUTLET Ø200
03 GAS CONNECTION 1/2"
04 STEAM CONNECTION 3/4"

	A	B	C	D	D1	E	F	G	H	I	J	K	L	M	N
SR-SC-11	1694	1447	689	1354	1422	68	785	855	735	95	821	575	1226	133	180
SR-SC-16	1694	1447	689	1354	1422	68	785	1125	735	95	821	575	1226	133	180
SR-SC-23	1812	1552	743	1430	1532	112	890	1255	735	205	862	575	1344	133	180